

# Sirocco

## Instruction card

### Safety Instructions

- Read the user manual carefully before use.
- Maximum load: 135 kg.
- Close side rail when raising/lowering
- Keep away from pivoting point when folding to prevent fingers trapping.

### 1 Operation

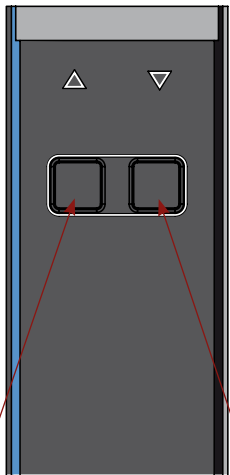

Up

Down

### Important!

This instruction card should not be seen as a replacement for the user manual.

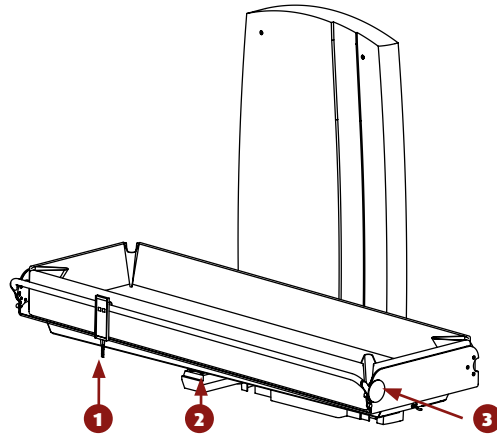

### Fold-up system

When the stretcher is folded up against the wall the side rail first needs to be lowered (see 3). When folding down the stretcher, **ENSURE** that there are no obstacles or persons under the stretcher!

### 2 Emergency stop

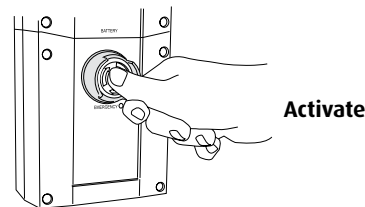

Activate

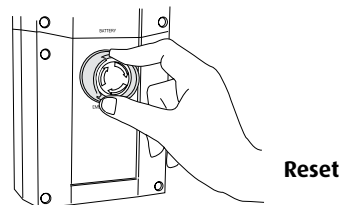

Reset

In the event of an emergency press the red button.

### 3 Opening and closing the side rail

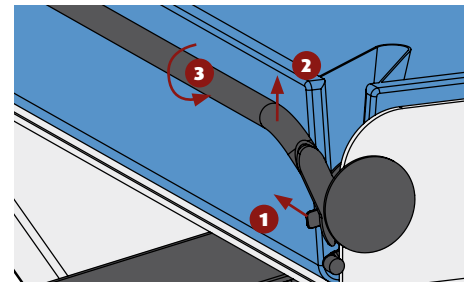

1. Unlock
2. Lift
3. Turn

When closing, side rail automatically locks in place.

### Changing the battery

When all boxes are black, the battery is fully charged. As soon as the plug symbol appears, the battery must be recharged as soon as possible.

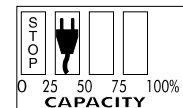

To change the battery, the stretcher must be folded up.

1. Unlock
2. Remove battery

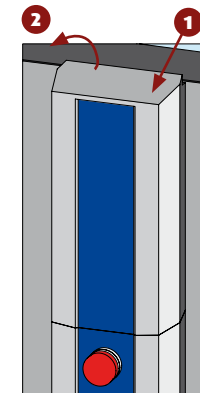

### Drainage

For effective drainage of water when showering, the hose must lead to a receptacle at a lower point.

To do this, take the hose off the hook at the foot end.

### Charging

Attach empty battery to the battery charger. The green light indicates that the battery is on. The orange light indicates that the battery is being charged and this will go out when the battery is recharged.

The recharged battery can stay attached to the charger.

Unlock the battery with one hand before removing, whilst supporting the battery with the other hand.

### Cleaning

After use each time, the stretcher must be cleaned with hot water and a normal household detergent.

Do not use a scourer or any other aggressive solvent.

For optimum and efficient cleaning, lift and/or remove the mattress. Dry the surface of the frame on which the mattress is situated.

In the event of defects, contact your dealer.