



Instructions for use
Tango Shower-toilet chair



Instructions for use

Tango

5100 5700

Shower-toilet chair

Basic UDI-DI: 872025610305951005700LK



Important:

Read these instructions carefully before using the Tango!

Date first used

User

Name

Address

Manufacturer

Lopital Nederland B.V.

Laarakkerweg 9











5061 JR Oisterwijk

T +31 (0)13 5239300

www.lopital.nl

info@lopital.nl

All of the aids produced by Lopital fulfil the following norms for medical products Class 1 (MDR (EU) 2017/745).

Explanation of symbols in 'instructions for use' and on labels			
	Note		Follow the instructions for use
	Date of production		Read cleaning and disinfecting protocol
	Maximum load		Antibacterial
	Global trade identification number		Temperature
	Serialnumber		Air pressure
			Humidity level

Contents

1.	Introduction	5
1.1.	Introduction	5
1.2.	Safety.....	5
1.3.	Warranty.....	7
2.	Use.....	7
2.1.	First use.....	7
2.2.	Working with the Tango.....	9
3.	Operation	9
3.1.	Wheel blocking.....	9
3.2.	Footrests.....	10
3.3.	Armrests.....	10
3.4.	Toilet function.....	12
3.4.1.	In combination with toilet.....	12
3.4.2.	Use of a bedpan or bucket.....	12
4.	Cleaning and maintenance.....	13
5.	Environmental conditions	14
6.	Removal of parts.....	15
7.	Technical specifications	15
7.1.	Structure.....	15
7.2.	Dimensions	15

1. Introduction

1.1. Introduction

The shower-toilet chair Tango is a medical device for caring for and washing clients in an ergonomically responsible manner. Comfort is the primary consideration for both the client and the carer.

The Tango can also be used as a toilet chair, in combination with a bedpan / bucket. The Tango is a shower-toilet chair with independent, folding armrests, polyurethane seat, rails for a bedpan and rotating and foldable footrests.



The frame of the Tango has an antibacterial coating. The coating contains silver ions. Antibacterial coating based on silver ions prevents dangerous micro-organisms such as bacteria, fungi and algae multiply and spread. The effectiveness was confirmed in several tests. Germs were demonstrably reduced in a short time to 99.99%. The coating only affects bacteria that are found on the surface and not on airborne micro-organisms. The coating protects users or others from disease-causing bacteria, germs, viruses or other harmful organisms. On a dirty surface, the coating loses its antibacterial properties. So proper cleaning and disinfection is still a must.

The expected technical lifetime of the Tango is 10 years, provided that daily and periodic maintenance is carried out according to the specified maintenance schedule (See chapter 4. Cleaning and maintenance).

The Tango is a medical class 1 product with CE marking. This marking is in accordance with the regulation MDR (EU) 2017/745.

1.2. Safety



A failure to comply with the following safety points and the further definitions in these instructions for use could lead to hazardous situations. Please read carefully before use.

Use

- Make sure that the Tango brake is applied before transferring clients.
- Notify the client before moving the Tango.
- Make sure that the client always places his/her arms on the armrests provided to prevent possible entrapment.
- Keep the armrests down / closed when moving the Tango.
- Always try to move backwards over obstacles (rather than forwards).

- It is not permitted to charge the Tango with more than 180 kg. / 400 lbs.
- The Reflex is only suitable for moving and caring for one person.
- Only use original parts, supplied by Lopital.
- Use the Tango in a clean and tidy working environment.
- Swimming pool locations are not considered to be 'normal conditions' and will substantially shorten the lifespan of certain components.
- The Tango cannot be used on a surface with a gradient over 5 degrees laterally.
- The Tango cannot be used on a surface with a gradient of over 10 degrees forwards / backwards.
- The Tango may only be used indoors.

Maintenance

- The Tango must be inspected and serviced at least once a year.
- In the event of damage to the seat, back or backrest, always replace them for reasons of hygiene.
- Servicing and maintenance of the Tango may only be carried out by persons authorised by Lopital.
- Service and maintenance must not be carried out while a client is sitting on the chair.
- If erroneous use, transport, an accident or improper maintenance leads to deformation of the Tango, it may no longer be used and you must contact the supplier.

In the event of breakdowns, you must contact Lopital or your local supplier.

E-mail: info@lopital.nl



The Tango shower-toilet chair should only be operated by competent personnel who have experience in working with the user target group and have watched the instruction / training videos on the Lopital website.



The Tango has been developed and produced for use in professional care environments.



Making changes to the construction can affect the safety of the Tango. Furthermore, the liability and guarantee conditions of Lopital lapse. As a result, the Reflex no longer meets the Medical Devices Regulation.

1.3. Warranty

All Lopital products are supplied with a 2-year warranty, on construction and / or material faults, unless otherwise stated. In the event of varying warranty terms, the exact period will be indicated on your invoice; this also serves as the warranty itself. Components and batteries that are subject to wear and tear will not fall under warranty unless there are clear construction and / or material faults.

2. Use

2.1. First use

In the picture below, the components of the Tango are named. In the event of damage, these parts can be replaced by authorised persons.





 Laarakkerweg 9 5061 JR Oosterwijk The Netherlands T: (+31)13-5239300 CE Weight: - kg / - lbs	GTIN (01) 8720256103---	Item no: -----
	(11) YYMMDD	
	SN (21) -----	
	-- kg / -- LBS Product type	



2.2. Working with the Tango

Step 1

If necessary, fold the armrests up (See paragraph 3.3. Armrests).

Step 2

If necessary, fold the foot plates up and fold the footrest frame up too (See paragraph 3.2. Footrests).

Step 3

The Tango must be put on the brakes before transferring persons (See paragraph 3.1. Wheel blocking).

Step 4

The client can take a seat in the chair. Support the client if necessary.

Step 5

Place both feet on the footrests (See paragraph 3.2. Footrests).

Step 6

Close the armrests once the client has taken a seat in the chair (See paragraph 3.3. Armrests).

Step 7

Notify the client about the processes you will be carrying out.

Step 8

Take the chair off the brake when you wish to move it (See paragraph 3.1. Wheel blocking).

3. Operation

3.1. Wheel blocking

- The brake can be applied on the Tango by pushing the blue lip (1) on the wheel downwards (See figure 1).
- In order to take the Tango off the brake, the same lip on the wheel must be moved upwards by tapping the upper side of the lip (2) (See figure 1).

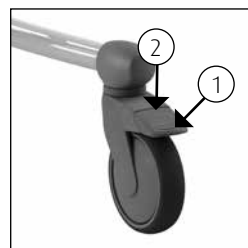

Figure 1 Swivel wheel.

Option: Directional wheel left front.

3.2. Footrests

- Before the client takes a seat in the Tango, the footrests or footrest frame must be folded upwards. There is now sufficient room to allow the client to easily take a seat (See figures 2 & 3).
- The carer or the client first raises one leg; the carer then folds the footrest (See figure 4). The same procedure is then carried out with the other leg.



Figure 2 Folding up footrests.



Figure 3 Folding up footrest frame.



Figure 4 Folding down footrests.

3.3. Armrests

- The independent folding armrests are easy to fold up.
- Protect the user when moving the armrests upwards / downwards.
- In the folded up position, they should not fall back down by themselves; in other cases: consult your supplier.



Figure 5 Armrest Tango.

Option for Tango: Armrests with front closure

- When the client has taken a seat on the Tango, the armrests with front closure can be folded down; these are then turned in front of the client.
- The armrests with front closure are secured in a horizontal position.
- The armrests can be unlocked by pressing the security catch at the hinging point on the frame (See figure 6). The armrest can then be turned up for the client and folded up.
- Always protect the client when folding the armrests up or down.
- The armrests can also be used as a support when taking a seat or standing up. Be aware that the armrests are not locked in all positions.

Option: Dual locking.

- The extra lock ensures that the front closure is also locked when turned away (See figure 8).



Figure 6 Armrest with front closure.



Figure 7 Armrest with dual locking.



When folding the armrests away, avoid the hinging point to prevent possible entrapment.



When folding the armrests away, avoid fingers or body parts becoming entrapped between the armrest and the back support.



The armrests or front closure must not be used as a lever arm (e.g. when moving the chair over an obstacle) or as a push / pull bar. You must not sit on it either. This could damage the Tango and / or present a hazard.



Figure 8 Armrest turned out.

3.4. Toilet function

3.4.1. In combination with toilet

- The Tango can also be moved over the toilet.
- Remove the inlay from the seat before the person sits down in the chair.
- The Tango can now be moved backwards over the toilet.



The Tango does not fit over every toilet.

3.4.2. Use of a bedpan or bucket

- If the Tango is being used as a toilet chair, the special guides under the seat can be used to accommodate a stainless steel / plastic bedpan or bucket.
- The bedpan or bucket is slid in from the back of the chair (See figure 9).
- If you are using the Lopital plastic bedpan, you must slide it as far forwards as possible (See figure 10).
- If you are using a stainless steel bedpan or bucket, the bedpan can be placed in 2 positions under the seat. At the front of the seat (See figure 11) or at the back of the seat (See figure 12).



In order to avoid injuries, we advise the carer to remove the inlay from the seat and insert the bucket or bedpan before the client takes a seat on the chair.



The Lopital plastic bedpan, stainless steel bedpan and bucket must be cleaned and disinfected after use, for example in a bedpan washing unit.



If the Lopital plastic bedpan, stainless steel bedpan or bucket has been used, it must be removed from the chair before the chair is moved or adjusted in height.



Figure 9 Bedpan.



Figure 10 Lopital plastic



Figure 11 Stainless steel bedpan, front.



Figure 12 Stainless steel bedpan, back.

4. Cleaning and maintenance

The Tango must be cleaned after every use, with water and regular household cleaning agents. PUR integrated foam components with IMC coating should be rubbed clean and disinfected. Do not use any abrasive or other aggressive cleaning products. If necessary, the PUR components can be disinfected with a solution of 70% ethanol or propanol.

The time the products must be left on the components has a significant impact upon the lifespan of the PUR components. As a result of the material properties of PUR, contact with sharp objects must be avoided. This could lead to damage or tears in the material. Finally, we would like to point out that non-critical parts of the PUR components must also be cleaned and disinfected.

Check the wheels regularly for hairs, dust and soap residues and remove when necessary. Maintenance and repairs to the Tango may only be carried out by authorised personnel.

Maintenance schedule	
After every use	<ul style="list-style-type: none"> • Clean chair with water and regular household cleaning products. • PUR foam components must be cleaned and disinfected. • Check to ensure all parts of the Tango are present, including the footrests, head support and inlay for the seat.
Weekly	<ul style="list-style-type: none"> • Check wheels for hairs, dust and soap residues and remove if necessary. • Check that the chair is still working correctly.
Annually	<ul style="list-style-type: none"> • According to the regulation MDR (EU) 2017/745 medical devices, a chair must be maintained according to the manufacturer's guidelines.

For a detailed explanation regarding cleaning and disinfecting, see the document 'Cleaning and Disinfection Protocol' on our website www.lopital.com/downloads.

5. Environmental conditions

Conditions during storage and transport

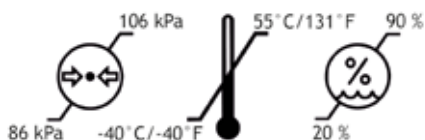

Conditions during use

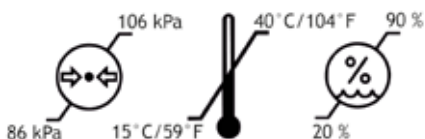

6. Removal of parts

All parts that are replaced or removed can be sent back to Lopital BV. You may also offer the parts to the engineer for destruction. We will ensure that all parts are processed in an environmentally-friendly manner.

7. Technical specifications

7.1. Structure

Frame:	Stainless steel and steel tubes and plates that are equipped with a two-layer powder coating
Hinge points:	Stainless steel
Wheels:	Plastic, Ø 12.5 cm / 4.9 inch, double blocking facility
Body support:	PUR (polyurethane)
Weight:	19 kg / 41.9 lbs
Maximum permitted load:	180 kg / 400 lbs

7.2. Dimensions

Surface area:	66 cm / 26 inch wide, 84 cm / 33.1 inch deep
Seat height:	55 cm / 21.7 inch

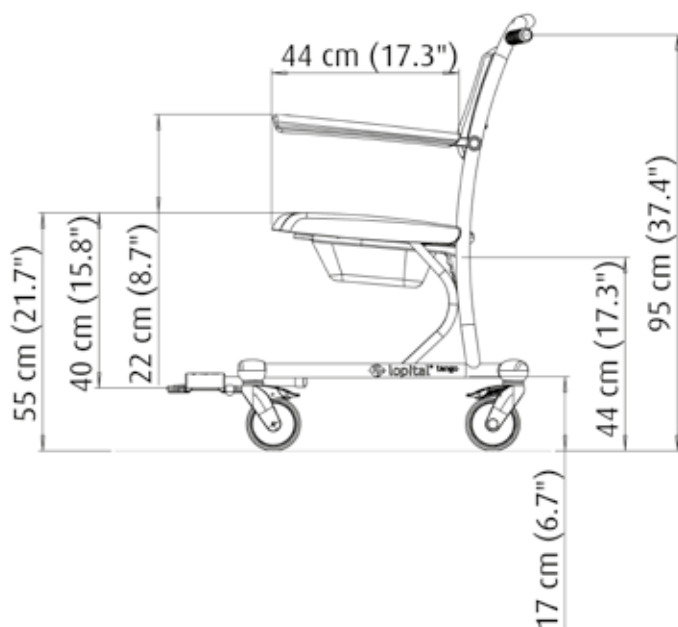
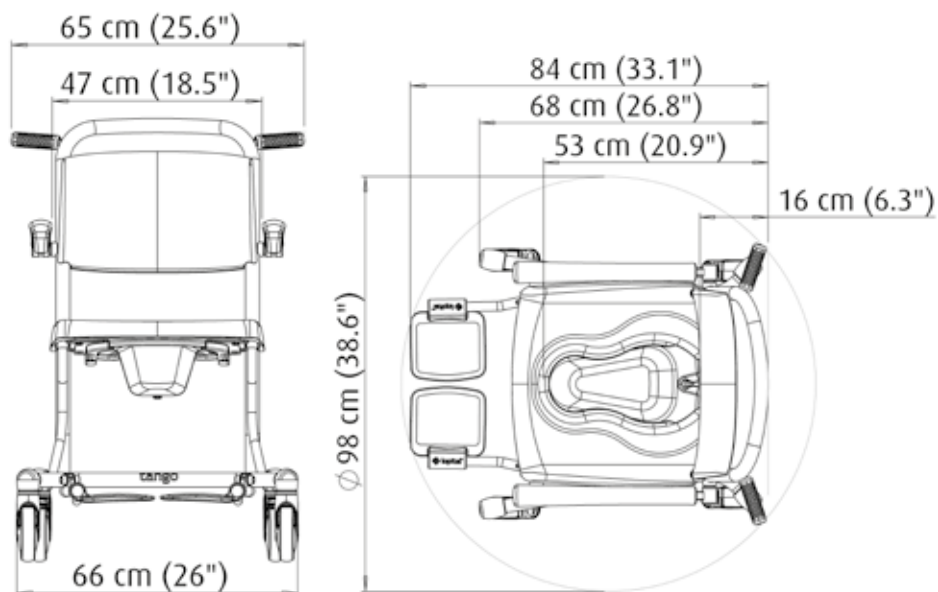

Manufacturer's Declaration of Conformity
CE marking in accordance with the Medical Device Regulation

Brand name:	Lopital
Medical device:	Tango
Device description:	Mobile shower-/toilet chair
Models:	51005700
Classification:	Class I
Basic UDI-DI:	872025610305951005700LK
Conforms to regulation:	Medical Device Regulation (EU) 2017/745
Standards applied:	<i>NEN-EN-ISO 14971:2019 Medical devices-Application of risk management to medical devices</i> <i>NEN-EN 12182:2012 Assistive product for persons with disability-General requirements and test methods</i> <i>ISO 17966:2016 Assistive products for personal hygiene that support users-Requirements and test methods</i> <i>EN ISO 62366:2007 Medical devices: Application of usability engineering to medical devices</i> <i>UNI-CEI-EN-ISO 13485:2016 Medical devices-Quality management systems-Requirements for regulatory purposes</i> <i>NEN-EN-ISO 9001:2015 Quality management systems - Requirements</i> <i>NEN-EN-ISO 14001:2015 Environmental management systems - Requirements with guidance for use</i>
Certificate/report no.:	Certificate: Reports:



Authorised signatory, Cees van Dam, director:

Signature:



Date:

2021-05-03

Place:

Oisterwijk

